

Family: Brantley | Item No. 4636

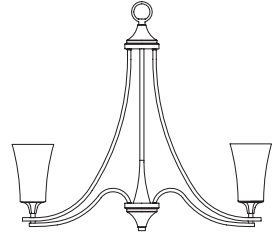

Drawing 1 - Assembly

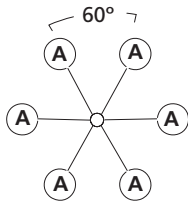

Drawing 2 - Glass Installation

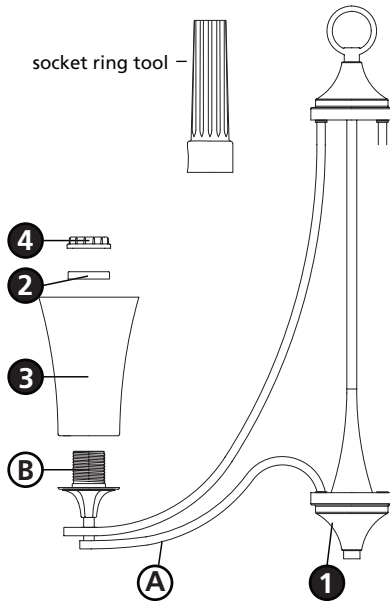

▼ start here

1

1. Find a clear area in which you can work.
2. Unpack fixture and glass from carton.
3. Carefully review instructions prior to assembly.

***** The construction of this fixture will be accomplished by first assembling the main body of the fixture, making all necessary electrical connections, hanging the fixture from the ceiling and then installing the glass.**

SAFETY WARNING: READ WIRING AND GROUNDING INSTRUCTIONS (I.S. 18) AND ANY ADDITIONAL DIRECTIONS. TURN POWER SUPPLY OFF DURING INSTALLATION. IF NEW WIRING IS REQUIRED, CONSULT A QUALIFIED ELECTRICIAN OR LOCAL AUTHORITIES FOR CODE REQUIREMENTS.

2

1. To assemble main body, spread arms (A) located on the main body assembly (1), until they are equally spaced 60 degrees apart - see **Drawings 1 & 2**.
2. Please refer to the hanging instruction sheet (I.S. 19) provided to hang fixture. Then refer back to this sheet to install glass.

3

1. To install glass, remove socket ring (4) and spacer (2) from socket (B) - see **Drawing 2**.
2. Slip glass (3) over socket (B).
3. Slip spacer (2) over socket (B).
4. Thread socket ring (4) back onto socket (B) and tighten using socket ring tool provided to secure glass (3). Note: Over tightening could cause damage to glass.
5. Repeat steps 1-4 for remaining glass.
6. Fixture can now be lamped accordingly.

Note: Maximum wattage for 4636 fixture is 100 watts per bulb.

3.6.09